



Product Information



Custom made industrial doors.

Rolflex is the designer and producer of the Compact door.

It is different from a traditional roller shutter or overhead door. The Compact door folds above the entrance while opening and saves not only space, but is also very easy to operate and is maintenance friendly. In this manual we will show all possibilities and benefits of our unique door.

Production

Compact doors are manufactured in a modern factory in The Netherlands.

Automated production processes will guarantee a constant high quality and meet European standards and regulations.

When the doors are produced, and after a final visual inspection, they are packed for transport, to ensure all doors are delivered complete and without damage.

Installation

To complement a high quality product it is important to work with skilled specialists in the field of installation and service.

In our own "Compact Academy" craftsmen from all over the world are trained to be skilled specialists.

You can be sure that always and everywhere a Compact Door specialist is available.



All rights reserved.

Reprinting, copying, processing, reissuing and or publication of the patented product or pictures in any form or on any medium are forbidden without the written permission of Rolflex Nederland BV. Subject to alterations. Rolflex Nederland BV cannot be hold responsible for printing errors.



Unique folding system

The Compact door has a unique and patented rail system without the use of balancing springs. This guarantees a long life cycle and the minimum of maintenance.

Service and installation network

The Compact Door is available almost everywhere around the world. A network of independent door companies are official Compact Door dealers and have this type of door in their delivery program. These dealers do have the specific knowledge of their own home market and together with Rolflex are able to deliver Compact Doors according to local regulations.



Your Compact Door
is our Compact Door

The Compact Door



Safety

Function

Slack cable device

Electrical operation

Fall safety device

Remote control

Light curtain safety

Control box with push buttons

















Automatic lock

Key switch



Contents



	Chapter	1	Page	6	Sandwich panels
	Chapter	2	Page	7	Standard colours
	Chapter	3	Page	8	Windows
	Chapter	4	Page	10 - 11	Full vision panels
	Chapter	5	Page	12 - 13	Full light panels
	Chapter	6	Page	14 - 15	Ventilation grating
	Chapter	7	Page	16 - 19	Wicket door
	Chapter	8	Page	20 - 21	Standard safety features
	Chapter	9	Page	22 - 25	Operation
	Chapter	10	Page	26 - 29	Dimensions and details
	Chapter	11	Page	30	Sealings
	Chapter	12	Page	31 - 45	Accessories
	Chapter	13	Page	46	Why a Compact door?
	Chapter	14	Page	47	Documentation and support
	Chapter	15	Page	48 - 49	Applications
	Chapter	16	Page	50	References
	Chapter	17	Page	51	Notes

1 Sandwich panels



Material panels

Insulated sandwich panels.
CFC-free polystyrene foam
covered with aluminium stucco
finished cladding.

Aluminium U-profiles on top and
bottom of the sandwich panels for
extra strength and stability.

Panel specifications

Top panel height variable.

- Insulation value EN12428
Panel: $U=0.76$ W/m²K
- Wind resistance EN12424
Class 2 – 5
- Water penetration EN12425
Class 2
- Air permeability EN12426
Class 2
- Noise reduction ISO140-3
Panel 20db(A)

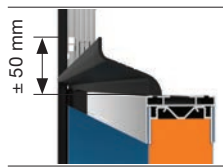
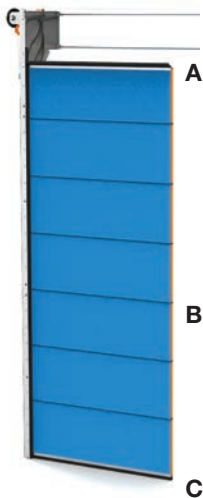

A

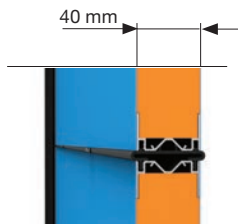

B

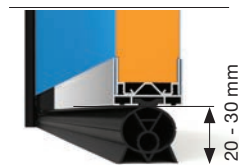

C

Standard colours 2



10 standard RAL colours.
Other RAL colours possible.

Warning

Dark RAL colours can cause problems in combination with sun heat and door panel width.



RAL 3002
Carmine red



RAL 5010
Gentian blue



RAL 5017
Traffic blue



RAL 6005
Moss green



RAL 7016
Anthracite grey



RAL 7032
Pebble grey



RAL 9002
Grey white



RAL 9006
White aluminium



RAL 9007
Grey aluminium



RAL 9016
Traffic white

Printing colors can deviate and are just a guide

3 Windows rectangular



Specifications

Window insulated acrylate with black plastic cover.

- Net glass surface: 0.18 m²
- Insulation value: U=2.8 W/m²K
- One window per meter panel

Dimensions

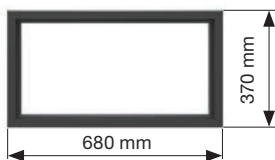

Detail

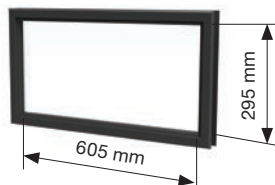

Specifications

Window insulated acrylate with black plastic cover.

- Net glass surface: 0.17 m²
- Insulation value: U=2.8 W/m²K
- One window per meter panel

Dimensions

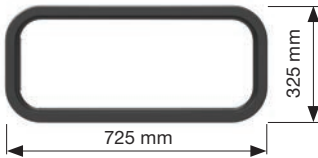

Detail



4 Full vision panels



Panel specifications

Aluminium profiles with vertical sections and fillings of choice.

- Standard finish anodized aluminium or RAL 9002
- Other RAL colours possible
- Thick: 40 mm
- Height: 610 mm
- Top panel height variable, minimum 135 mm
- Fillings of choice
- Number of fillings is variable and of choice

Dimensions

- From 6000 mm opening width a maximum of two full vision panels is possible in door blade
- The maximum width for a full vision panel is 7000 mm



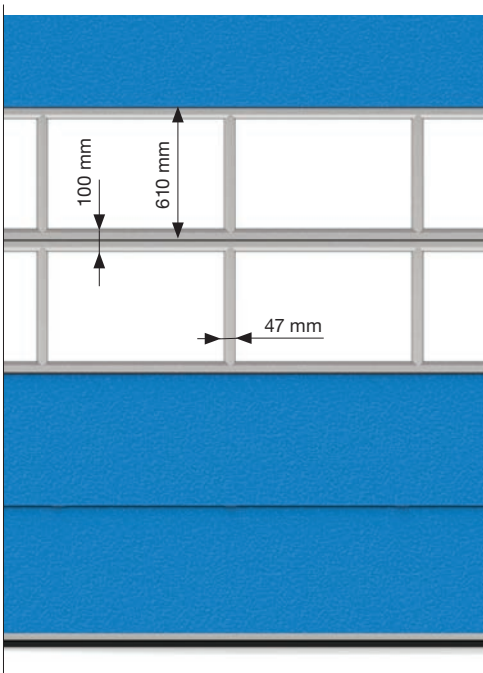

Specifications

- Full vision panel with fillings of choice
- On the inside of the door blade white plastic click-lists with rubber seals are used to fix the fillings in place
- These click lists are suitable for fillings of 4 mm or 17 mm thickness
- Click lists can be painted in RAL at choice.



Filling 4 mm

- Single acrylate
- Single polycarbonate
- Single safety glass
- Stainless steel netting



Filling 17 mm

- Insulated acrylate
- Insulated polycarbonate
- Insulated polycarbonate twin-wall
- Insulated sandwich



Delivery of plastic click-lists

- For filling of 4 mm
- For filling of 17 mm

5 Full light panels



Panel specifications

Aluminium profiles without vertical sections, filling twin-wall polycarbonate.

- Standard finish anodized aluminium or RAL 9002
- Other RAL colours possible
- Thick: 40 mm
- Height: 610 mm
- Top panel height variable, minimum 135 mm
- Transparent insulated polycarbonate twin-wall

The full light door blade is made of transparent lightweight polycarbonate break resistant panels. A combination with solid sandwich panels or full-vision panels is possible.



Cross view



Clear



Opal



Green



Full light panels 5



6 Ventilation grating



Ventilation grating 452 cm²

- Anodized aluminium
- Air permeability net 452 cm²

Dimensions

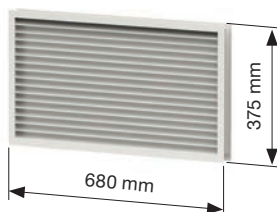

Ventilation grating 215 cm²

- Black plastic
- Air permeability net 215 cm²

Dimensions

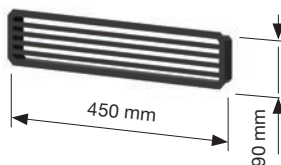



Ventilation grating 185 cm²

- Aluminium RAL 9010 (white)
- Lockable
- Air permeability net 185 cm²

Dimensions

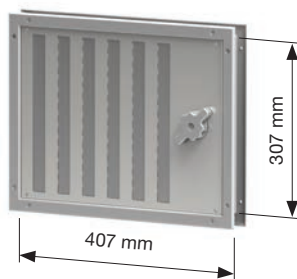

Ventilation grating 45 cm²

- Aluminium RAL 9010 (white)
- Lockable
- Air permeability net 45 cm²

Dimensions

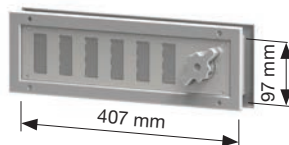

7 Wicket door



Specifications

The wicket door aluminium profiles will be delivered in anodized aluminium finish.

Dimensions

- Net opening width 850 mm
- Height (from floor level) 2100 mm
- Threshold ± 120 mm

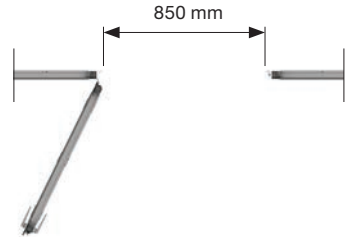

Closure

- Door closer on bottom panel
- Door catcher on top panel
- Lock in panel 2
- Rubber seal in door frame

Safety

Electrical safety switch integrated in the door frame prevents the door running automatically when the wicket door is open.

Position wicket door

Hinge side, opening side and position of wicket door in the door blade [see page 17](#).

Position Full vision panels

Between 4000 - 6000 mm opening width full vision possible only from panel number 3.

1. Hinge left /
outside opening



2. Hinge left /
inside opening



3. Hinge right /
outside opening



4. Hinge right /
inside opening



Inside



Inside



Inside



Inside



Left



Right



Middle



Middle



7 Wicket door (detail)

Door catch (top panel)

Door lock and handle

Safety switch

Door closer (bottom panel)

90 mm extra top space required for:

- 50 mm for special bottom profile
- 40 mm for door closure installed on bottom

Euro cylinder lock
Cylinder 30/35 with 3 keys.

Panic lock (option)
Open door from the inside.

KABA Lock (Option)



Specification

A side door inclusive galvanized steel frame. This door can be installed next to the Compact door and has the same look.

Opening dimensions for side door 1000 mm x 2450 mm (WxH) with fascia panel made of door panels. The side door does not have a threshold and is always opening outwards. Delivery includes a door closer and standard hardware with cylinder lock.

Option

- Panic lock
- KABA lock

Site construction (by others)

For installation of the Compact Door tracks and side door frame an installation frame of 120 mm minimum is required.

Dimensions

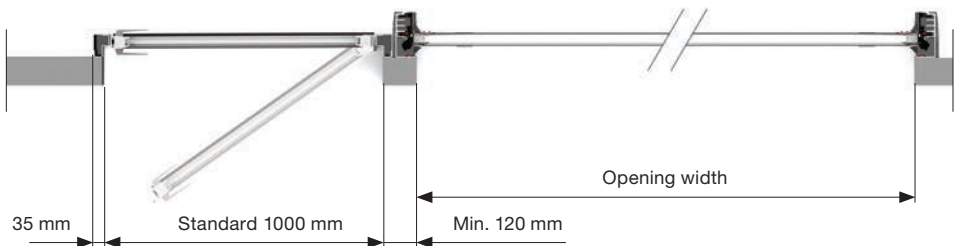

8 Standard safety features



General

Safety regulations and norms EN12604 en EN12453 Delivery according EURO norm EN 13 241-1 and CE-certificate.

Slack cable device

Motor will be disconnected when cable tension is gone.



Side rail covers

Plastic covers to protect the holes in the side rails and to avoid injury.

Front rail covers

Safety covers with warning tape to prevent injury to fingers and hands.

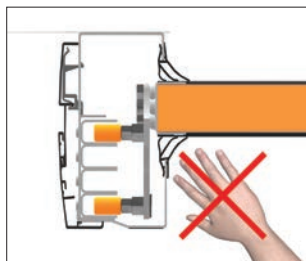

Fall safety device



Fall movement

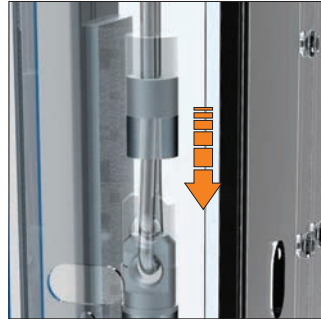

Fall stop

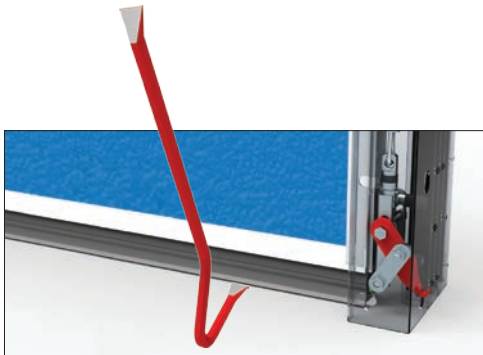

Function

The fall safety device prevents the door blade from falling down in case the steel cables break. The bottom brackets will catch in the side rail holes.

Anti lift system

The door blade will be held in position automatically by the bottom brackets which will catch in the side rail holes.

9 Operation (control)

Electrical operation with control box CS300

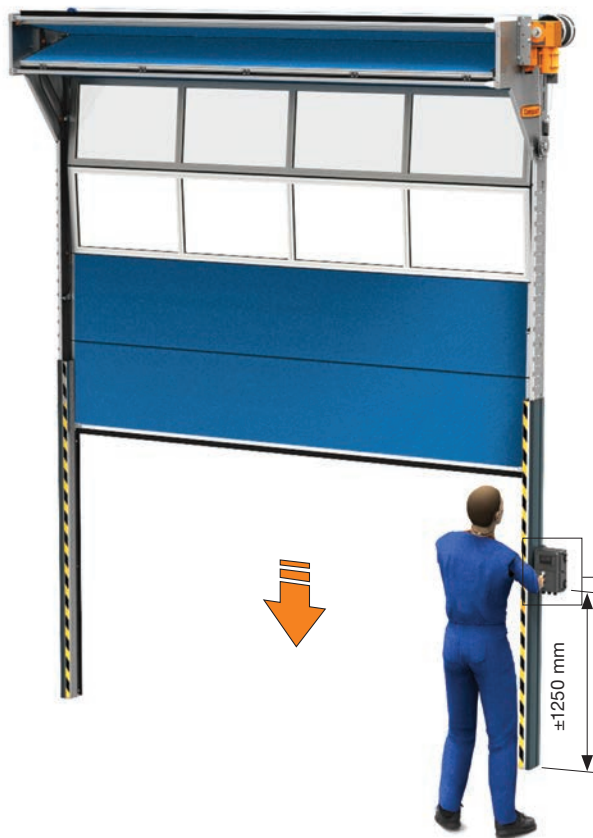

Opening of the door

After an impulse the door will completely open automatically.



Detail CS300

Closure of the door with dead man operation

The supervisor who is operating the door will keep control of the closing door. In case of any dangerous situation he will stop the door immediately.



Automatic closure of the door with light curtain safety

With this safety device it is possible to close the door automatically without the supervision of an operator. The light curtain controls the door opening till a height of 2500 mm and detects obstacles.

Once the safety device is activated the closing movement will stop and the door will go up again, thus avoiding danger to materials and persons.

Remote control



4-Channel transmitter

Transmitter for maximum operation of 4 doors.

- Frequency 433 MHz
- Inclusive clip holder



99-Channel transmitter

Transmitter for maximum operation of 99 doors.

- Frequency 433 MHz



Remote control receiver

Receiver for 4-channel hand hold transmitter or 99-channel transmitter.

Operation till ± 20 meter.
Frequency 433 MHz.

ATTENTION

Only in combination with light curtain safety.

9 Operation (motor)

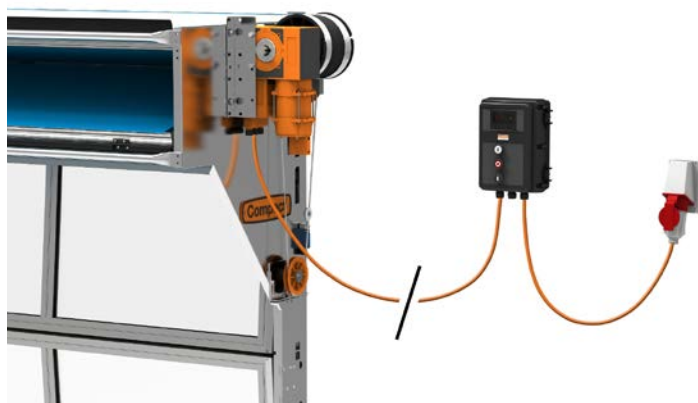

MOTOR AND SPECIFICATIONS

Motor	RC150	RC175	RC250	RC300	RC300T
Speed (cm/sec) ¹	19 cm/sec	19 cm/sec	19 cm/sec	19 cm/sec	15 cm/sec
Voltage (volt)	1 x 230 V	3 x 400 V	3 x 400 V	3 x 400 V	3 x 400V
Power (ampere)	6,5 A	2,8 A	3,3 A	3,4 A	3,4 A
Power (kilowatt)	0,75 kW	0,75 kW	1,1 kW	1,3 kW	1,3 kW
Frequency (hertz)	50 Hz	50 Hz	50 Hz	50 Hz	50 Hz
Plug (neutral not necessary)	2- pin, 16A	5- pin, 16A	5- pin, 16A	5- pin, 16A	5- pin, 16A
Potential free contact	4	4	4	4	4
Duration (%) ²	25%	60%	60%	60%	60%
Cycles open/close per hour	12x	20x	20x	20x	20x
Protection class ³	IP54	IP54	IP54	IP54	IP54
Max. weight doorblade (kilogram)	155 Kg	190 Kg	275 Kg	389 Kg	455 Kg

¹ The Compact door is also available as a high speed door. Opening speed till 60 cm/sec. (see page 35)

² The switch duration is an indication of the number of door cycles. In case of intensive use it is possible to choose an 80% motor (30x open and closing per hour).

³ The motor is standard protected against dust and water increase (IP54). In a wet environment it is possible to choose a IP65 protection.



Motorposition is universal, left or right.

Various installation positions are possible (front, top) (see page 28-29).

Every motor is equipped with an emergency crank handle in case of power failure.

Optional it is possible to choose an emergency chain operator (see page 40).

Cable length between motor and control box is standard 7 meter.

Optional it is possible to choose a cable length of 15 meter.

Plug at 3 x 400 V > 5-pole, 16 A.

Plug at 1 x 230 V > 2-pole, 16 A.

Other motor types on request (3 x 230 V or 60 Hz).

Standard turning direction pre-set right.

Trafo in control 24 V DC, maximum 250 mA.

Socket provided on site.

10 Dimensions and details (measurements)

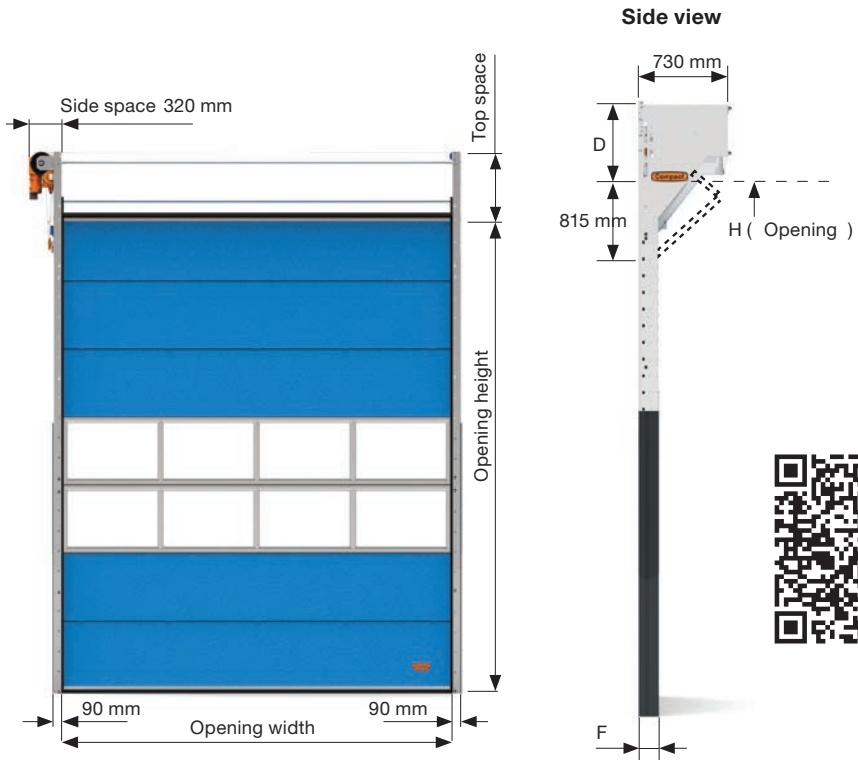

Extra space required for [Top motor](#) – [Front motor](#) – [Protection shield](#) - [Wicket door](#) - [Storm profiles](#)

Top view

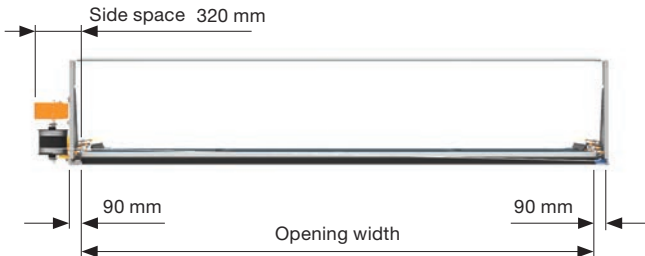

Measurements

H (mm) min.(<) - max.(>)	D (mm)	F (mm)
$0 < h \leq 3080$	410	140
$3081 < h \leq 4300$	520	160
$4301 < h \leq 5520$	630	180
$5521 < h \leq 6740$	770	200
$6741 < h \leq 7960$	890	220

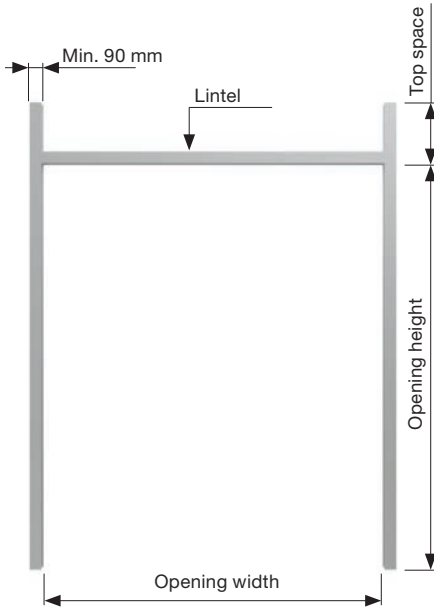

Detail

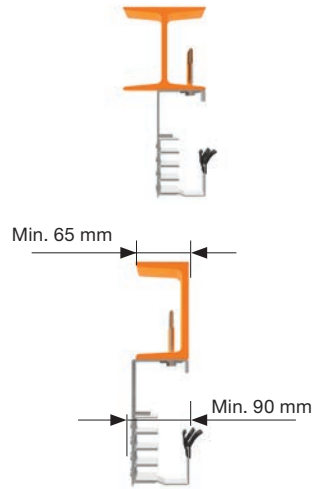

Lintel

For installation the lintel is not necessary. Only to protect the building against weather influences. The top seal needs a surface to close.

Specifications

We advise a threshold on the bottom to prevent water going into the building.

Side view

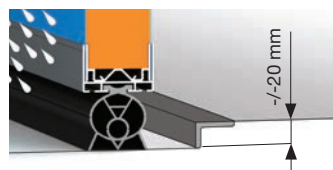

Installation frame

Installation frame has to be stable, flat and square.

Installation on steel, stone, concrete or wood possible.

Threshold

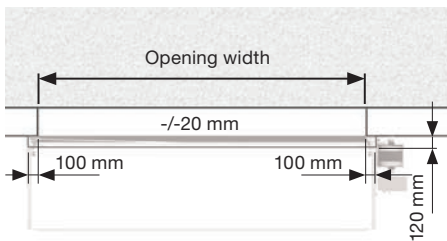

10 Dimensions and details (motor)

Side motor

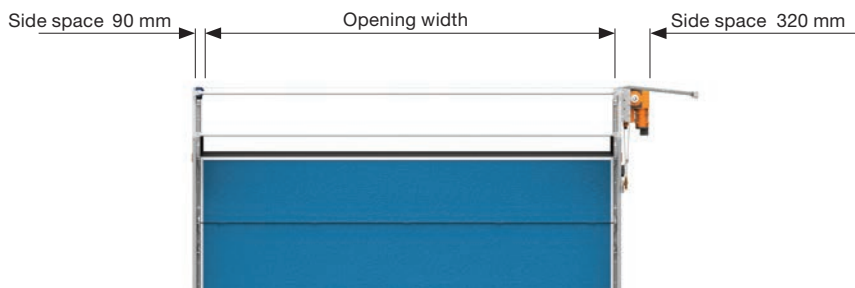

Top motor

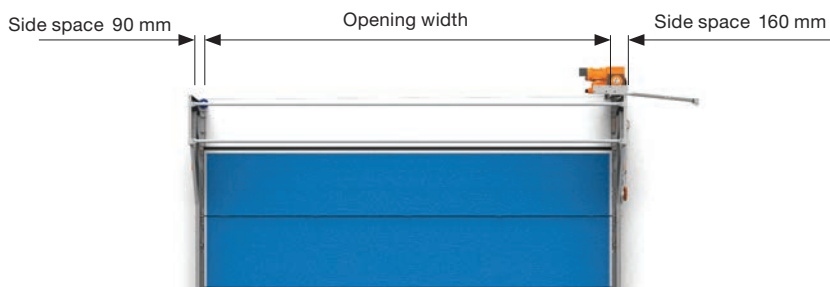

Front motor

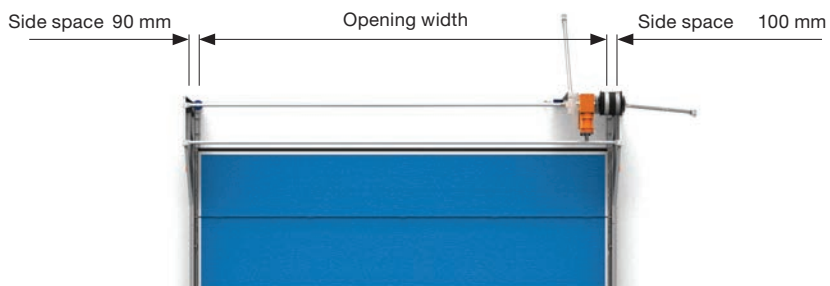

Specifications

Side motor parts set

- Standard

Detail



Side motor

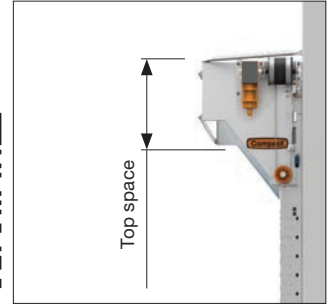

Specifications

Top motor parts set

- Necessary when the side space is restricted but enough top space is available.

Detail



Top motor

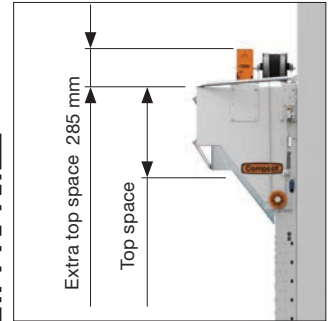

Specifications

Front motor parts set

- Necessary when less than 320 mm side space is available and only restricted top space is available.

Limits

- Maximum weight of the door blade is 275 kg
- Maximum opening height is 5520 mm

Detail

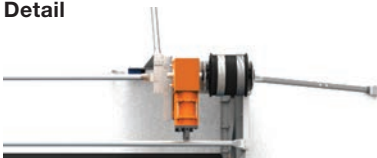

Front motor

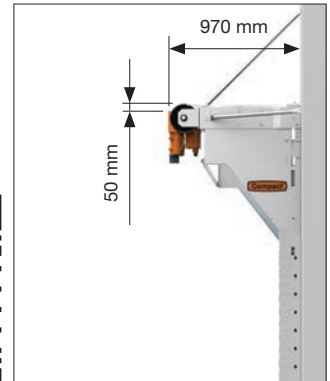

11 Sealings

Optimum closing and insulation

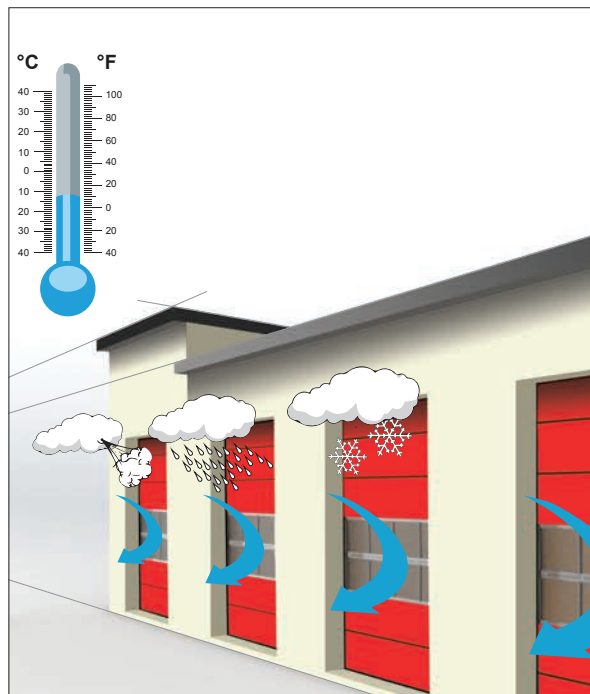

Top rubber



Bottom rubber

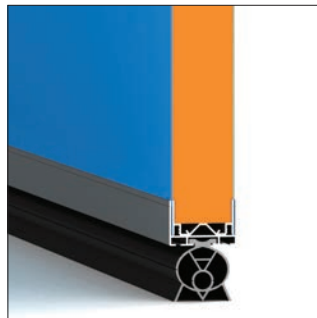

Intermediate seal



Intermediate seal

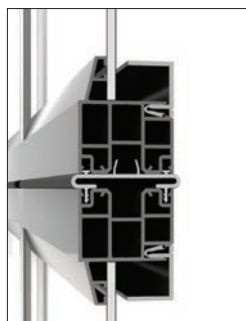

Side seal

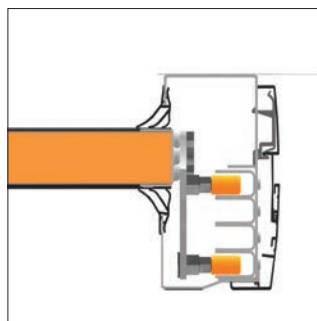



Storm profiles

The anodized aluminium profiles are positioned between the door blade panels and make the door blade extra strong. With these profiles the Compact door is extra protected against high wind loads.

Compact doors from 6000 mm and wider are provided with storm profiles as standard.

For other dimensions the storm profiles are available on demand. This could be necessary in high wind areas like in coastal areas or mountains.

Detail

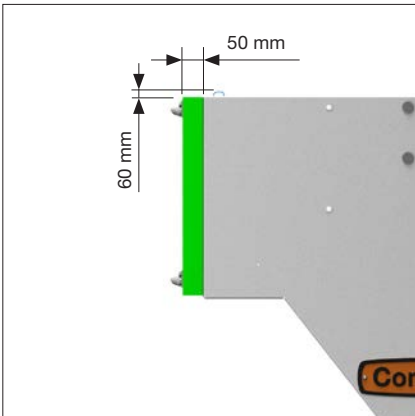

Stormprofiles in RAL colour

Profiles in RAL colour of choice as an option for aesthetic reasons.

Side view



12 Accessories (fascia panels)

Fascia door panel - Sandwich



Side view



Fascia door panel - Full Vision



Side view



Fascia door panel - Sandwich

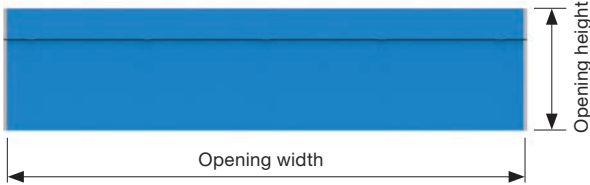

Specifications

Sandwich fascia panels similar to the door panels are used.

Delivery in 10 standard colours or colour of choice.

Delivery including aluminium U-profiles.

Fascia door panel - Full Vision

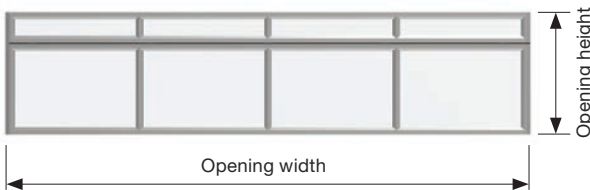

Specifications

Full vision panels similar to the door panels are used.

Delivery in 2 standard colours (anodized aluminium or RAL 9002) or in a RAL colour of choice. Filling of choice.

Delivery including aluminium U-profiles.

Top view fascia panel

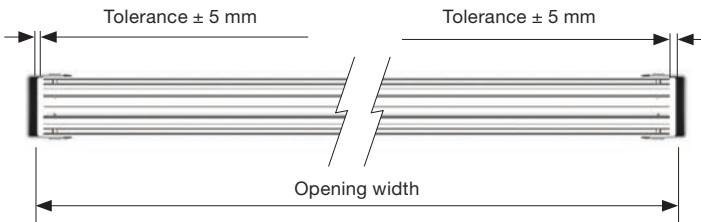

12 Accessories (external installation)



Cover door package

The Compact door package is protected by a cover. This cover is delivered in component form and can be easily installed over the door package. Available in your RAL colour of choice.

Cover door panels only in combination with a side or front motor, not with [top motor](#).

Additional installation space required: 60 mm.

Max width: 5860 mm.



Cover front motor

The door package and the front motor of the Compact door can be fitted with a protective cover. This is supplied in component form and can be easily installed to protect motor and door package. Available in your RAL colour of choice. Motor side is universal (left or right).

Cover motor only in combination with a side- or front motor, not with [top motor](#).

Additional installation space required: 60 mm

Max. width 5860 mm.



Cover side motor

The side motor of the Compact door can be fitted with a protective cover. This is supplied in component form and can be easily installed to protect the motor alone. Available in your RAL colour of choice. Motor side is universal (left or right).

Cover motor only in combination with a side- or front motor, not with [top motor](#).

External installation

Due to the folding system the door is suitable for external installation as well. In this situation the door must be protected against weather influences such as moisture and water, rain and snow.

Additional measures for external installation

- Emergency manual control
- Secured with lock snap-in glazing on inside

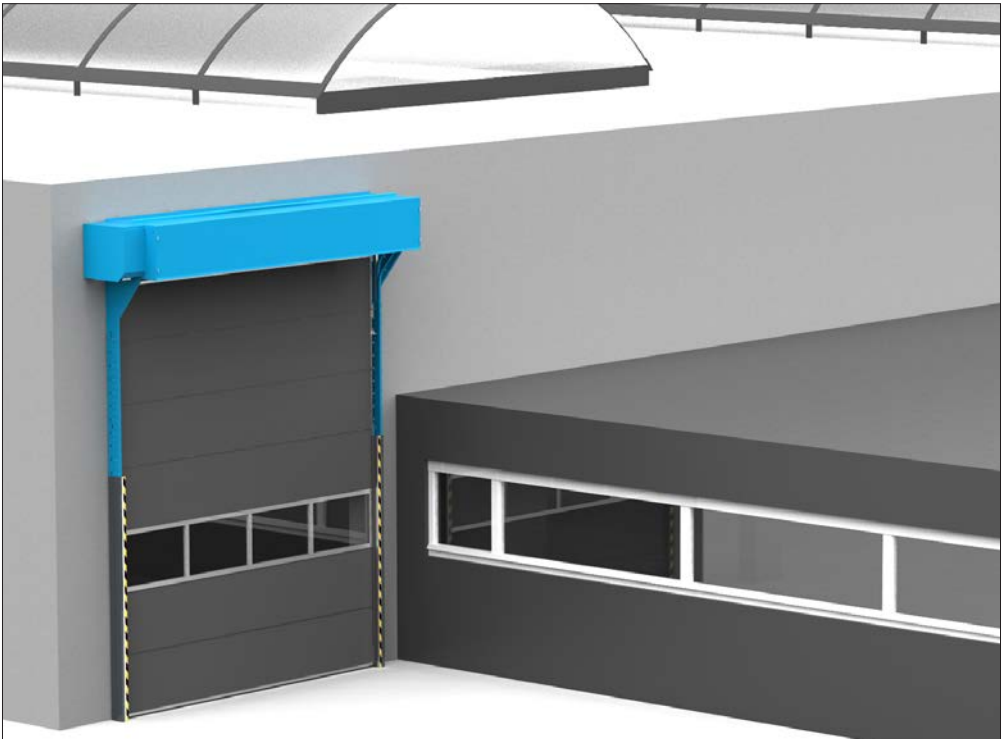

Advice at external installation

- [Protection cover](#)
- [Powder coated rails and hardware](#)
- [Motor and control box IP65](#)
- [Stainless steel fasteners](#)

12 Accessories (powder coating)

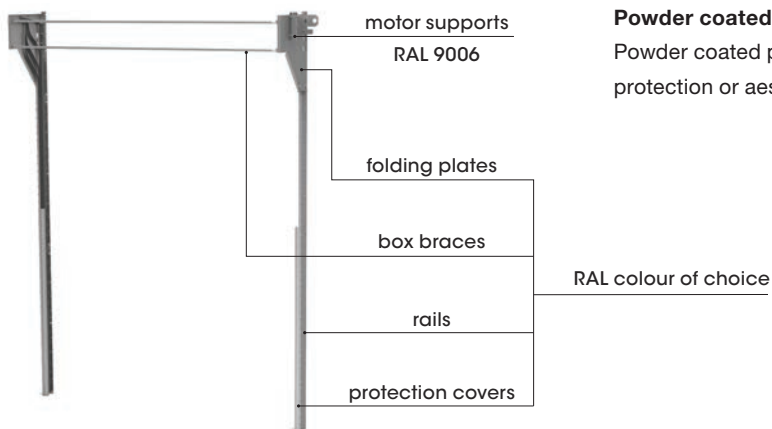

Powder coated tracks

Powder coated parts for extra protection or aesthetic reasons.



Powder coated hardware

Powder coated parts for extra protection or aesthetic reasons.
RAL colour 9006

Top - bottom profile in RAL colour

Profiles in the same colour as the door blade for aesthetic reasons.

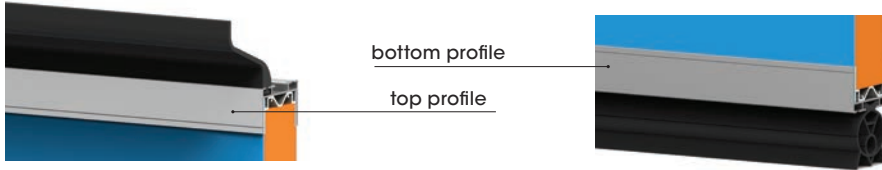

Stainless steel fasteners

Optimum protection against damp and weather influences.

For use in damp spaces such as car washes or for external installation.

Extra

Water drainage at sides of panels for maximum prevention of dripping. For use in car washes.



12 Accessories (control box)

Control box CS300 Class IP65



LED monitor

To adjust end switches open and close position



LCD monitor

To adjust end switches for open and close position and to program the control functions.



Emergency button

In case of an emergency the door can be stopped immediately.



Lock control box

Switch off the controls to avoid unwilling operation of the door.



Summer/winter switch

Half open function for summer and winter. Also to switch off automatic time closure.





High speed motor with frequency control system

The Compact door can be delivered as a high speed door.

- Opening speed adjustable till maximum 60 cm/sec
- Closing speed 30 cm/sec

Specifications high speed motor RC500R

- 3 x 400 V
- 4,7 A
- 2,2 kW
- 50 Hz
- 5-pin, 16A

This motor will be delivered with the following options:

- LCD monitor for programming the control system
- Emergency chain opener in case of power failure
- Light curtain safety
- Switch duration 80% (for intensive use, 30 cycles per hour)
- Safety class **IP65** (dust and water protected)
- Emergency button on control box

Limits

- Maximum dimensions 5000 x 5000 mm (WxH)
- Maximum weight of door leaf is 190 Kg
- Only available at side motor position (minimum side space required is 350 mm)

12 Accessories (extra controls)

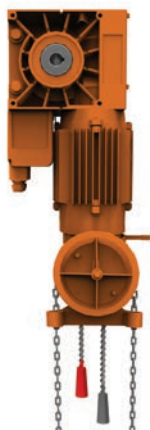

Emergency chain opener

In case of a power failure the door can be operated by hand from floor level.

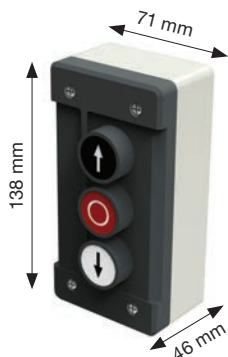

Additional push button

Push button
OPEN – STOP – CLOSE,
Class IP65.



Pull switch

Operation of the door from lift truck and other vehicles.
Class IP65.

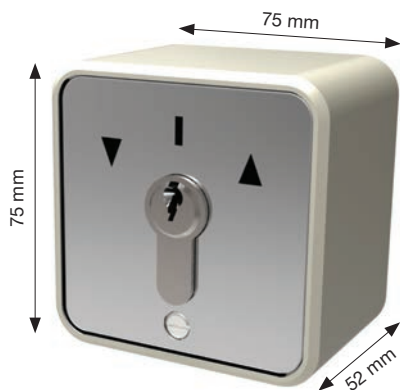

Key switch

Key switch with Euro Cylinder and 3 keys.

Operation by key movement.



Key switch UP-STOP-DOWN

Key switch with Euro Cylinder and 3 keys.

Operation by push buttons.

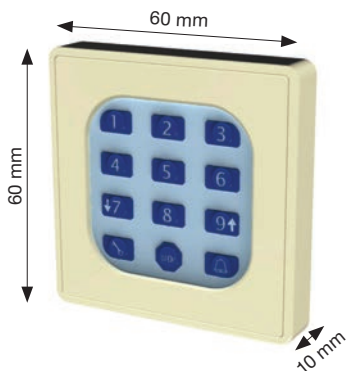

Pin code unit

With a personal pin code the door can be operated.

12 Accessories (remote control)

Photocell

For extra safety or to operate the door as an extra opening and close signal. Standard photocell with reflector, [Class IP65](#).

For heavy use or washing bays we advise transmitter and receiver photocell.

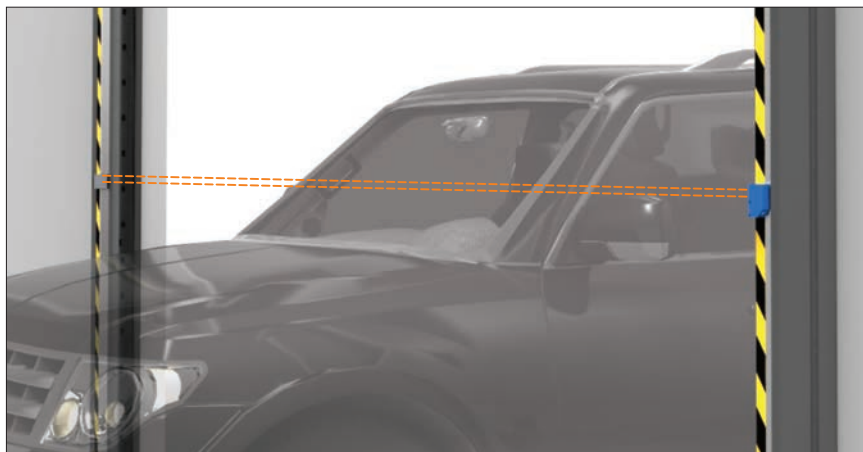

Reflector

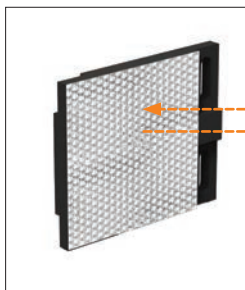

Standard

Photocell

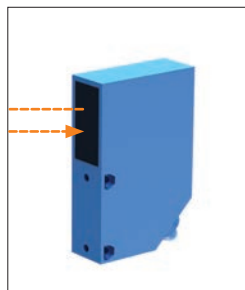

Transmitter



Carwash

Receiver



Radar

Infrared adjustable radar.

- Operation till 5 m

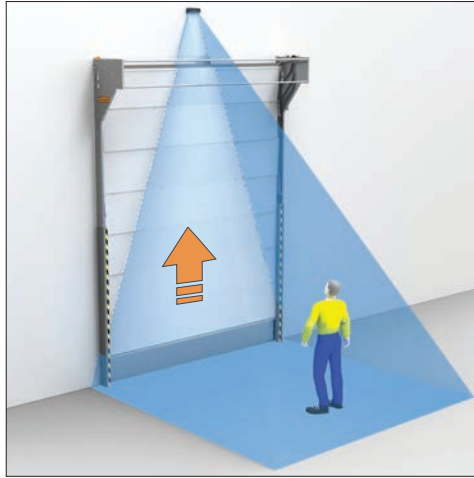

Warning light

Flashlight as warning system, [Class IP65](#).

Traffic light (combinations possible).

Colors green, orange and red available.



12 Accessories (options)



Automatic time closure

After the door is open it can be closed automatically after an adjustable time schedule. 0 to 600 sec.

ATTENTION

Only in combination with [light curtain safety](#).

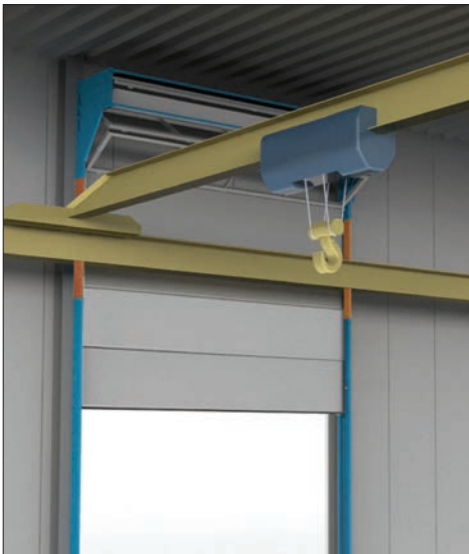

Extended track set

Additional vertical rails for extra height.

It can be useful to increase the height of the folding system and side rails for example when using a crane.

ATEX

(For Compact doors in potentially explosive environments).

There are two possible ATEX models: Mechanical and Electrical.

Mechanical ATEX for Compact folding doors

The mechanical elements of the Compact folding door comply with:

Directive 2014/34/EU (ATEX 114)

Directive 2014/34/EU reference: II 3 GD T6

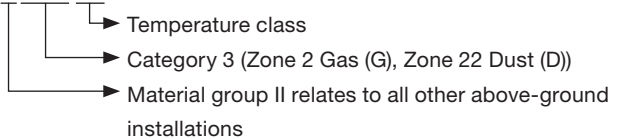

Adjustments to Compact folding door with Mechanical ATEX

- Automatic static discharge of the door
- Transformer for slack rope guard including blue ATEX cables

Allowance must also be made for a few aspects:

- The motor must be fitted outside the explosive area, this may mean that adjustments have to be made to the motor, e.g. an extended shaft, possibly in combination with a front-fitted motor.
- The control box must be fitted outside the explosive area.
- The Compact folding door is only available with a “deadman’s control” in ATEX-compatible models.

ATEX for electrical components of the Compact folding door

The motor and the controls can also be offered in ATEX-compatible models. Combinations are possible that allow positioning the motor or the controls outside the explosive zone.

Please ask.



Compact Folding Door

Saving Space with more Opportunities

No balancing springs

Choose your desired glazing.

Select either a standard colour or a preferred RAL colour.

Insulated door panels

A wicket door is a possible option also with glazing.

Unique vertical folding panels

Select the type of operation and the motor position. Choose your accessories.

Self-supporting on side rails



Design freedom



Space saving



No overhead supports



Smooth operation



Workspace lighting



Low maintenance



Overhead cranes



Tubing and sprinklers



Automotive



External installation



Wicket door



Safe vehicle access





Tools

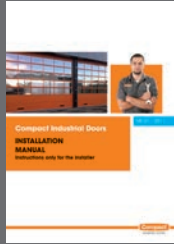

Installation



Parts

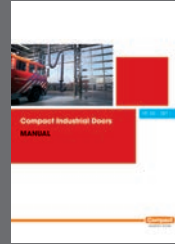

User

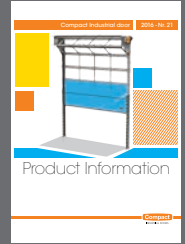

Product

DESIGN YOUR OWN DOOR!

Visit www.rolflex.com/en/doors/request-offer and receive your design and price directly in your mailbox.



1
Enter the dimensions of the door.



2
Choose your desired glazing.



3
Select either a standard colour or a preferred RAL colour.



4
A wicket door is an option, also with glazing.



5
Choose the door operation type and motor position.



6
Request quotation: The quotation will be send by mail. Please select additional information.

www.rolflex.com for more information, quotation, pictures and video's.

15 Applications

- Automotive
- Authorities
- Emergency Services
- Transport and Logistics
- Special projects
- Commercial buildings
- Explosive environment



Audi

Audi
Doors One

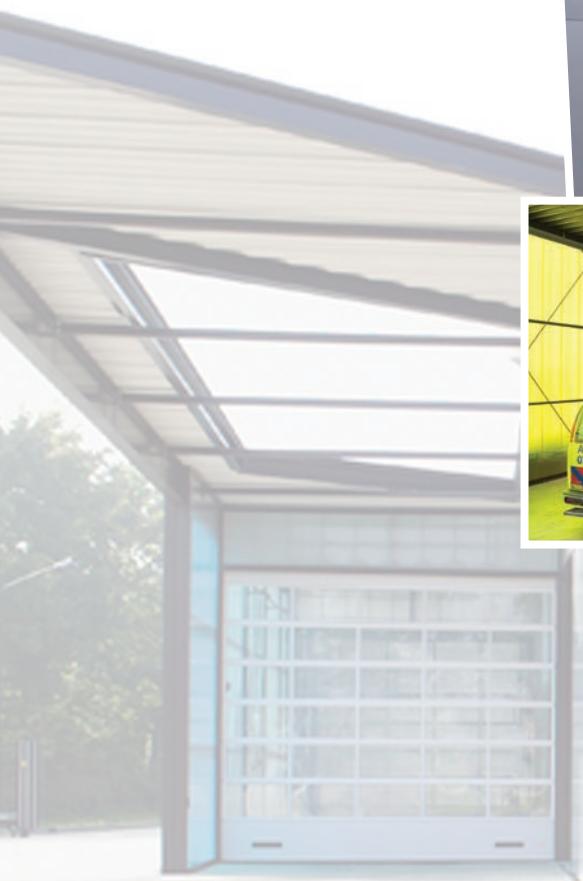



16 References

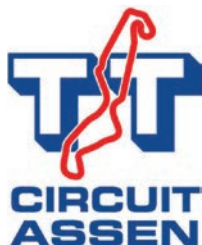

www.rolflex.com

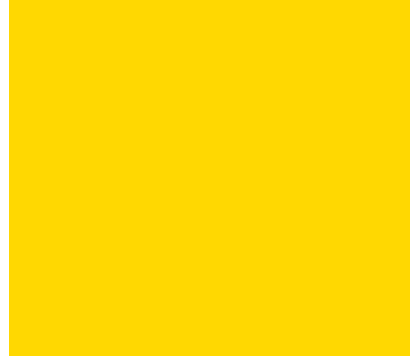

**THE COMPACT
DOOR
THE NEW
GENERATION
OF INDUSTRIAL
DOORS**



Rolflex Nederland b.v.

Nijverheidsweg 23 NL-7081 AE Uift Netherlands.

Phone + 31 (0)315 69 59 54 **Fax** + 31 (0)315 69 59 50

E-mail info@rolflex.com

Compact

FOLDING DOOR

Rolflex

MANUFACTURER OF
THE COMPACT DOOR